

DUX WATER HEATERS

HOT WATER SOLUTIONS PRODUCT GUIDE



Quality on every job
Reliability you can trust

(07) 3423-3754

<https://1stchoicehotwater.com.au>



Find us on
Facebook

www.facebook.com/ahws.au

BEFORE YOU MAKE A DECISION ABOUT WHICH HOT WATER SYSTEM IS RIGHT FOR YOUR HOME, THINK ABOUT:

- How much hot water you use daily
- Whether the size of your hot water system is sufficient for your household
- How much space you have
- Does your home has access to natural gas or LPG to heat your hot water
- How environmentally conscious you'd like to be
- Your budget
- Whether the system will be located inside or outside
- If selecting solar, whether you have adequate north facing roof space for collectors



proflo[®] for homes of all sizes

TOUGH BUT STYLISH HOT WATER SYSTEMS THAT WILL GO THE DISTANCE.

If you're looking to replace an existing electric storage water heater, Proflo is an ideal solution - available in a variety of tank sizes for homes of all sizes and delivering full mains pressure.

PROFLO 25 & 50L

- NEW Proflo 50L boasting a compact 670mm height, making it an easier fit into tight cupboards whilst still delivering 50L of hot water
- Attractive appliance white finish
- Made in a Noritz manufacturing facility
- 7 years tank warranty, 1 year parts and labour*

PROFLO 80 - 400L

- 80L - 400L Proflo water heaters now boast a larger anode to increase tank life
- Hard-wearing, tough polymer base resists damage and moisture
- Extra durable Y class commercial grade enamel
- Made in Australia
- 10 years tank warranty, 1 year parts and labour*

RANGE FEATURES

- Easy installation, water connections on both sides of tank
- Low maintenance and long service life
- Full flow pressure to all outlets
- Can be installed indoors or out#

NO. OF ADULTS & CHILDREN		CAPACITY
Continuous Tariff	Off Peak	
1 Adult icon		25L
2 Adult icons		50L
3 Adult icons		80L
4 Adult icons		125L
5 Adult icons	2 Adult icons	160L
6 Adult icons	3 Adult icons	250L
7 Adult icons	4 Adult icons	315L
8 Adult icons	5 Adult icons	400L

Adult icon can represent dishwasher or washing machine.
 Continuous Tariff; Provides power so that your water can be heated at any time of the day or night.
 Off Peak; Generally only provides power for your water heater for between 6-12 hours a night - check with your local electricity retailer for details of off-peak hours.
 #Plug in models can only be installed indoors.



SO MANY SIZES FOR HOT WATER
 YOU CAN'T GO WRONG.

electric storage

prodigy® 4 & 5 star gas storage

NO EXTRA SPACE NEEDED TO INSTALL AN EFFICIENT PRODUCT.

Gas storage hot water systems give you full mains pressure with a constant, strong stream of hot water.

If you're looking to replace an existing gas storage water heater, the Dux Prodigy is an ideal solution. The Dux 5 star range has a smaller footprint than other 5 star units, allowing easy replacement of older systems.

PRODIGY 4 STAR

- Market leader when it comes to hot water recovery
- Now matches the first hour capacity of the old 3 star models
- 7 years tank warranty, 1 year parts and labour*

PRODIGY 5 STAR

- Easy installation, with water connections on both sides of the tank
- Patented flue damper design on reduces heat loss
- 10 years tank warranty, 1 year parts and labour*

RANGE FEATURES

- New burner technology means faster recover rates and more hot water when you need
- Identical footprint with existing 3 star gas storage unit, ensuring easy replacement
- Mains pressure hot water
- Cylinder insulated with robust foam for added durability
- No power point required so hot water continues, even with no power
- Inline foam filled provides better insulation and a more robust design
- Available in both natural gas and propane



FIRST HOUR CAPACITY	STORAGE CAPACITY	RECOVERY	FIRST HOUR CAPACITY
Prodigy 4 & 5	135L	130L	265L
Prodigy 4 & 5	170L	146L	316L

	CAPACITY (L)	PEOPLE	
prodigy	135		3-6
prodigy	170		4-7

Both Prodigy 4 and 5 star gas storage models feature the same footprint as existing 3 star gas storage water heaters, allowing easy replacement of older systems.

NEW AND IMPROVED TECHNOLOGY
MAKES THE DIFFERENCE

gas continuous flow

INSTANT HOT WATER, HEATING WATER ONLY AS IT'S NEEDED.

Compact and efficient, Dux's latest range of Continuous Flow units are an excellent option for Australian homes. Dux gas continuous flow water heaters heat the water only as needed, not wasting energy by keeping water in a tank hot, earning it a 6 star (or higher) energy rating.

With several delivery options available, ensure you select a Dux continuous flow water heater that best suits to the number of outlets in the home.



- Condensing delivers over \$1000# savings over the 12 year warranty of the heat exchanger
- Providing Australian homes with superior technology straight from Noritz, Japan's leading manufacturer of household water heaters
- Features superior condensing technology that boasts over 90% thermal efficiency by capturing additional heat in the secondary heat exchanger
- Smallest domestic condensing gas water heater
- No standby pilot light
- 6 star or higher energy rating
- Made in Japan
- 12-year warranty on heat exchanger, including 3-year full parts and labour*



SIZING	MODELS		
	17L/min	21L/min	26L/min
No. of Outlets	2	2-3	3

CONDENSING

Water is heated a second time using the heat from the exhaust gas, reducing wasted energy and lowering the exhaust temperature.

EXHAUST TEMPERATURE IS ONLY 50°C

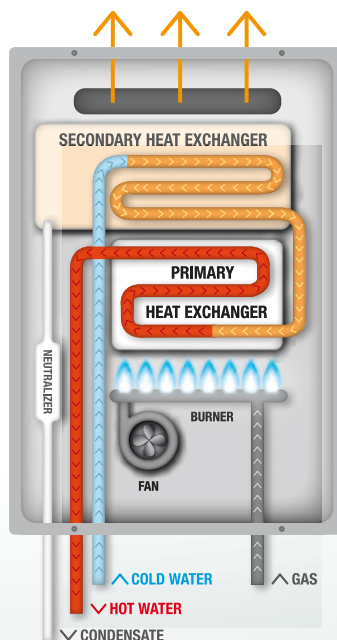

(Condensing technology)
Thermal efficiency = 90-96%

NON-CONDENSING

Water only passes through one heat exchanger and the energy from the exhaust gas is wasted.

EXHAUST TEMPERATURE IS APPROX 200°C

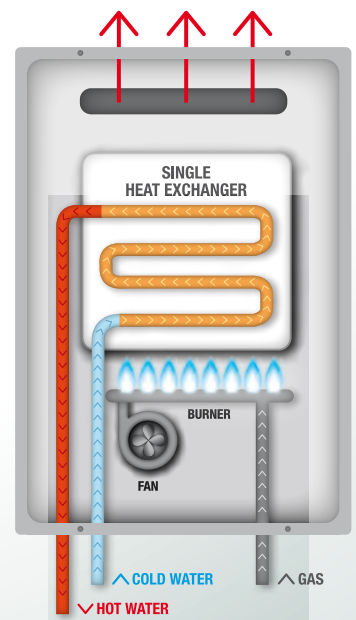

(Conventional technology)
Thermal efficiency = 80-84%

ACCESSORIES



Accessories include separate controllers that allow you to select the hot water temperature you prefer – a welcome safety feature for families.

Optional accessories for Dux Continuous Flow water heaters include:

- Pipe cover (CF-H33-K600)
- Recess boxes (RBM3)
- Anti-theft kit (H1210)
- Flue diverters (see spec pages for part number)

HOT WATER ON DEMAND
WHEN YOU NEED IT

#Running cost savings compared to a 5 star natural gas storage water heater over the 12 year warranty of the heat exchanger.

airoheat® *air-sourced heat pump*

POWERFUL, EFFICIENT AND ENVIRONMENTALLY FRIENDLY.

If your home doesn't offer suitable roof space and orientation for installing solar collectors, Airoheat is the next best choice in environmentally friendly water heaters, without the need for solar panels.

Working like a refrigerator but in reverse, it takes air in from outside the tank and uses it to heat water. Its patented in-tank heating coil ensures direct heat transfer, eliminating exposure to heat loss issues often associated with other styles of heat pump.



- Composite condensation tray is designed for rapid drainage in high rainfall areas
- Dual anodes provide greater protection against tank corrosion
- Patented in-tank heating coil to improve heat transfer
- Improved thermal efficiency minimises heat loss due to a fully insulated storage tank and a robust refrigeration system
- Water connections on both sides of tank provide easy installation
- 5-year tank warranty, 2-year refrigerant components, 1-year full parts and labour*

**5
YEAR
WARRANTY***



airoheat® <i>heatpump</i>		
CAPACITY (L)	PEOPLE ¹	
250		3-5

PRODUCT CODE: D2FHG4HW0C	STC ZONE*					
	1	2	3	4	5 [†]	
250L HEAT PUMP	22	21	26	27	27 [†]	

[†]Refer to www.dux.com.au/zones for postcodes in Zone 5.
STC values are subject to change without notice and are correct at time of printing. STCs calculations are based on continuous tariff. Size figures are based on environmental averages which can effect the performance of solar and heat pump heaters. Adult icon can represent dishwasher or washing machine. Based on connection to continuous tariff.

**AUSTRALIA'S MOST HIGHLY AWARDED
ENVIRONMENTAL WATER HEATER**

sunpro® *free energy from the sun*

OUTSTANDING EFFICIENCY TO HELP REDUCE ENERGY BILLS.

If you're aiming to reduce your carbon footprint, choose a Sunpro solar water heater. Sunpro uses the sun's energy to heat water via solar panels. Comes with either an electric or gas booster ensuring hot water on cloudy days or in times of high demand.

Sunpro will save you money on energy bills, providing an economical, sustainable hot water solution for years to come.

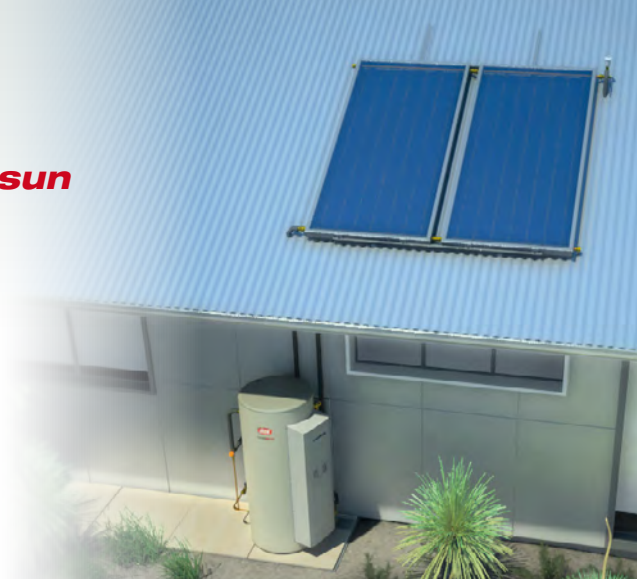

- Next generation split system design provides flexible installation locations without the need for expensive roof reinforcement
- Multi-temperature sensors on a vitreous enamel tank configuration enable optimum solar gain while reducing the risk of overheating
- High performance collectors ensure efficient transfer of heat to water
- Patented Hotlogic® processor maximises energy from the sun
- Efficient, polyurethane insulated storage tank
- Supplies mains pressure hot water
- 5-year tank and panel warranty, 1-year parts and labour*



	CAPACITY (L)	PEOPLE
electric sunpro®	250	2-4
electric sunpro®	315	3-5
electric sunpro®	400	4-7
gas sunpro®	315	2-6

sunpro® solar		STC ZONE*				
		COLLECTORS	1	2	3	4
250L	D2F136T2AC	2	38	41	36	32
315L	D3F136T2AC	2	38	42	37	32
400L	D4F136T3AC	3	44	45	45	40
315L	DN15DT2DC/ DL15DT2DC	3	38	42	35	30



DID YOU KNOW...

Dux® solar water heaters are supplied with a genuine Reliance® brand Dux® Solar tempering valve adjusted to Dux® specifications to ensure maximum hot water delivery.

STC values are subject to change without notice and are correct at time of printing. STCs calculations are based on continuous tariff. Size figures are based on environmental averages which can effect the performance of solar and heat pump heaters. Adult icon can represent dishwasher or washing machine. Based on connection to continuous tariff.

**INVIGORATING HOT WATER
IN ANY KIND OF WEATHER**

PROFLO[®] ELECTRIC STORAGE

proflo small electric

SPECIFICATIONS	25S124P [^]	25S1	50S124P [^]	50S1
Storage Capacity (L)	31	31	50	50
Hot Water Delivery (L)	25	25	50	50
Net Weight Empty (kg)	17	17	23	23
Element Sizes (kW)	2.4	2.4, 3.6	2.4	2.4, 3.6
Relief Valve Pressure (kPa)	1000	1000	1000	1000
Max Inlet Pressure (kPa)	800	800	800	800

[^] Proflo Plug-in model (plugs into standard power point)

TANK DIMENSIONS (MM)

	25L	50L
A Overall Height	455	670
B Overall Diameter	405	405
C Hot Water Outlet	275	490
D Cold Water Inlet	145	145
E Electrical Entry	70	70

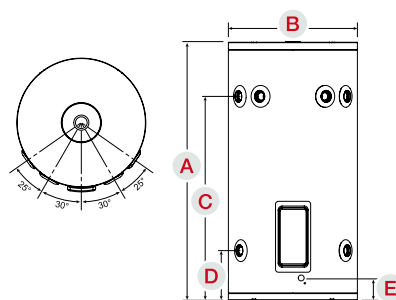

proflo large electric

SPECIFICATIONS	80T1	125T1	160T1	250T1	315T1	315T2 TWIN ELEMENT	400T1	400T2 TWIN ELEMENT
Storage Capacity (L)	88	130	161	259	321	321	415	415
Hot Water Delivery Rating (L)	80	125	160	250	315	315	400	400
Twin Element Boost Capacity (L)	-	-	-	-	-	60	-	85
Element Sizes (kW)	1.8, 2.4, 3.6	1.8, 3.6	2.4, 3.6	3.6	3.6	2 x 3.6 or 2 x 4.8	3.6	2 x 3.6
Net Weight Empty (kg)	41	51	59	72	93	93	115	115
Relief Valve Pressure (kPa)	1400	1400	1400	1000	1000	1000	1000	1000
Max Inlet Pressure (kPa)	1120	1120	1120	800	800	800	800	800

TANK DIMENSIONS (MM)

	80L	125L	160L	250L	315L	400L
A Overall Height	925	1090	1315	1445	1765	1705
B Overall Diameter	490	530	530	620	620	705
C Cold Water Inlet	160	190	190	195	195	220
D Hot Water Outlet	735	865	1095	1210	1530	1445
E Electrical Entry	85	100	100	105	105	130

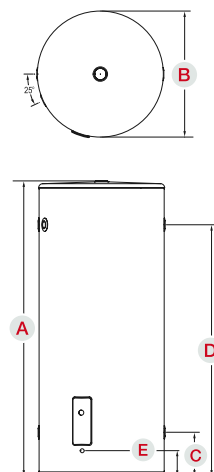

All Dux proflo water heaters are dual-handed for ease of installation and operate at 240V AC single phase electricity supply.

PRODIGY[®] GAS STORAGE

SPECIFICATIONS	prodigy ⁵		prodigy ⁴	
	135DB5N/135DB5P	170DB5N/170DB5P	135ZB4N/135ZB4P	170ZB4N/170ZB4P
Nominal Capacity (L)	135	170	135	170
Net Weight Empty (kg)	73	87	72	86
Relief Valve Pressure (kPa)	1400	1400	1400	1400
Gas Consumption (Propane) (MJ/h)	28	32	28	32
Gas Consumption (NG) (MJ/h)	29.5	33.5	29.5	33.5
Energy Star Rating	5.3	5.3	4.5	4.2

TANK DIMENSIONS (MM)				
A Overall Height Outdoor	1600	1900	1600	1900
B Hot Water Outlet	1325	1620	1325	1620
C Cold Water Inlet	220	220	220	220
D Gas Inlet	300	300	300	300

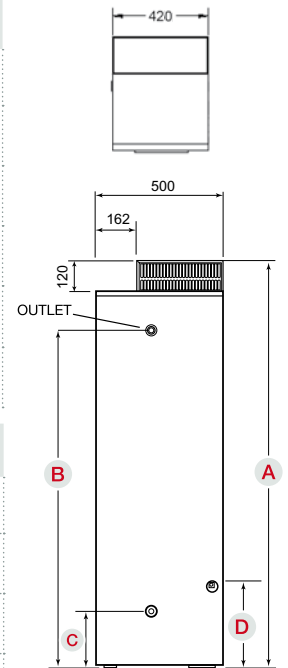

AIROHEAT[®] HEAT PUMP SYSTEM

SPECIFICATIONS	airoheat [®]
	D2FHG4HW0C
Storage Capacity (L)	250
Net Weight Empty (kg)	107
Power Consumption (General Tariff - kW)	1.2
Max Water Supply Pressure (kPa)	800
Relief Valve Pressure (kPa)	1000
Rated Voltage	240V ac

Not suitable for installation in alpine areas or areas above 1000m.

TANK DIMENSIONS (MM)	
A System Height	1710
B System Width	660
C Inlet	195
D Outlet	1210

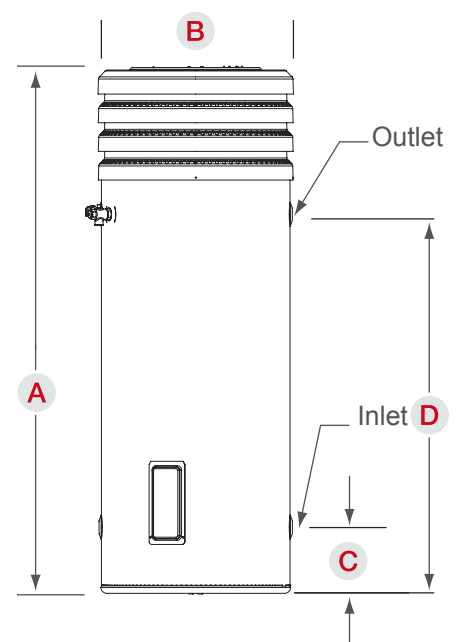

ALWAYS HOT GAS CONTINUOUS FLOW

MODELS	CONDENSING MODELS		NON-CONDENSING MODELS		
Model Number - up to 50°C	21ECB5N / 21ECB5L	26ECB5N / 26ECB5L	17ENB5N / 17ENB5L	21ENB5N / 21ENB5L	26ENA5N / 26ENA5L
Model Number - up to 60°C	21ECB6N / 21ECB6L	26ECB6N / 26ECB6L	17ENB6N / 17ENB6L	21ENB6N / 21ENB6L	-
Model Number - up to 75°C	-	-	-	-	26ENA6N / 26ENA6L
Flow Rate (l/min @ 25° rise)	21	26	17	21	26
Min Operating Flow Rate (l/min)	2.4	2.4	2.4	2.4	2.4
Gas Consumption MJ/h - NG	145	175	125	159	200
Gas Consumption MJ/h - LPG	149	185	130	158	200
Star Rating	6.7	6.7	6.0	6.1	6.0
Gas Type	NG or LPG	NG or LPG	NG or LPG	NG or LPG	NG or LPG
Weight (kg)	17	18	14	15	22
Max water supply pressure (kPa)	1000	1000	1000	1000	1000
Min water supply pressure (kPa)	200	200	200	200	200
Cold Water Connection	20mm ¾"	20mm ¾"	20mm ¾"	20mm ¾"	20mm ¾"
Hot Water Connection (mm)	20mm ¾"	20mm ¾"	20mm ¾"	20mm ¾"	20mm ¾"
Gas Connection (mm)	20mm ¾"	20mm ¾"	20mm ¾"	20mm ¾"	20mm ¾"
Flue Diverter Part Number	CF-S37	CF-S37	CF-L39	CF-L38	CF-L18

DIMENSIONS (MM)	CONDENSING MODELS		NON-CONDENSING MODELS		
	21L/min	26L/min	17L/min	21L/min	26L/min
Model					
A Width	350	350	350	350	350
B Depth	170	170	170	170	170
C Height - Unit	520	520	520	520	600
D Height - Including Brackets	575	575	575	575	655
E Hot Water Outlet (From Back)	45	45	40	40	40
F Cold Water Inlet (From Back)	87	87	80	80	97
G Gas Connection (From Back)	40	40	40	40	40
Gas Connection Length (From Base)	50	50	50	50	49
H Cold Connection Length (From Base)	48	48	48	48	48
Hot Connection Length (From Base)	45	45	45	45	44
I Drain Outlet (From Back)	21	21	N/A	N/A	N/A
J Hot Water Outlet (From Centre)	138	138	131	131	131
K Drain & Cold Water Outlet (From Centre)	63	63	24	24	54
L Gas Connection (From Centre)	128	128	128	128	100

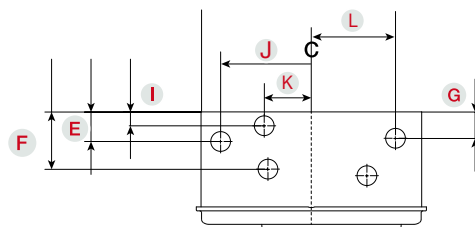
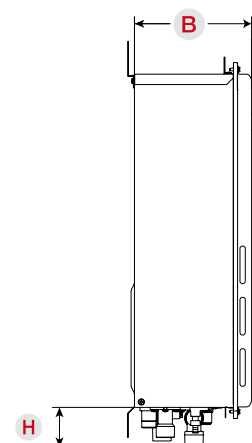
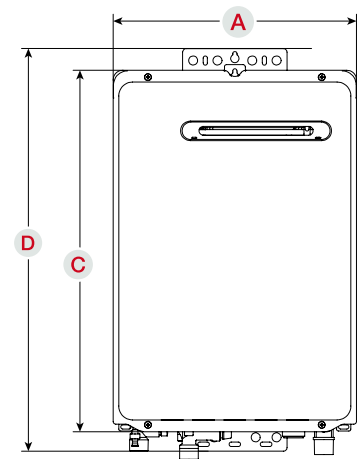

SUNPRO® ELECTRIC BOOSTED SOLAR

	sunpro®		
TANK SPECIFICATIONS	2F136S	3F136S	4F136S
Storage Capacity (L)	259	321	415
Element Boost Capacity (L)	120	150	215
Net Tank Weight Empty (kg)	80	91	113
Relief Valve Pressure (kPa)	1000	1000	1000
Max Inlet Pressure (kPa)	800	800	800
TANK DIMENSIONS (MM)			
A Tank Height	1445	1765	1705
B Tank Diameter	620	620	705
C Tank Width	715	715	800
D Outlet	1210	1530	1445
E Inlet	195	195	220
F Solar Return	630	840	640

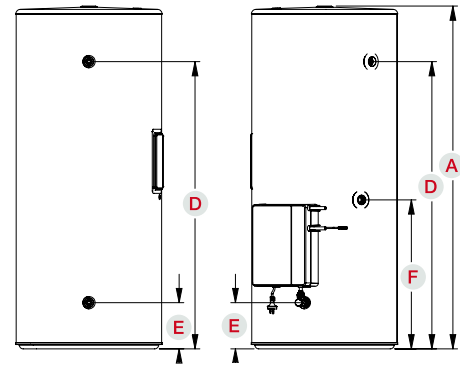
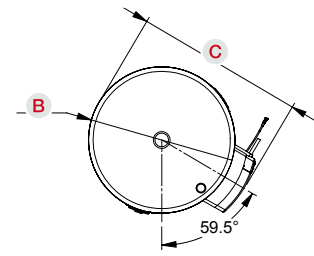

SUNPRO® GAS BOOSTED SOLAR

	sunpro®
TANK SPECIFICATIONS	DN15DT2DC / DL15DT2DC
Nominal Capacity (L)	315
Gas Consumption (MJ/Hr)	45
Gas Type	Natural/Propane
Net Weight Empty (Kg)	112
Cold Water Socket Size (mm)	RP¾"/20
Gas Pipe Inlet Size (mm)	RP½"/15
Relief Valve Pressure (Kpa)	1000

TANK DIMENSIONS (MM)	
A Tank Height	1765
B Tank Diameter	620
C Tank Depth	750

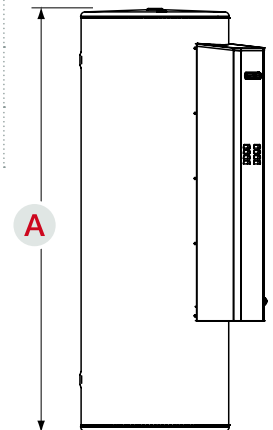
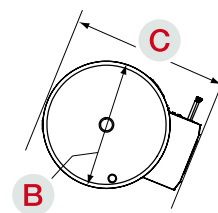

SOLAR COLLECTORS

PANEL SPECIFICATIONS	2AP
Total Area (m²)	2
Weight Without Water (kg)	43
Glass Thickness (mm)	3.2
Glass Material	Toughened, Low Iron

PANEL DIMENSIONS (MM)	
Panel Height	2014
Panel Width	1080
Panel Depth	82



1300 365 116

dux.com.au

*WARRANTY

Full warranty terms and conditions are in the product's Owners Manual, visit www.dux.com.au/warranty-terms for full details and conditions which apply.

Sales: 1300 365 116 Service: 1300 365 115 or visit dux.com.au for more.

© 2016 Dux Manufacturing Limited ABN 19 077 879 844. Lackey Rd, PO Box 209 Moss Vale, NSW 2577.

The information supplied was correct at time of printing. Specification and materials may change without notice.

® and ™ Trademarks of Dux Manufacturing Limited. FEB 2018